

Operation Manual

CX20 1/8 DIN

Microcomputer Based Conductivity/Resistivity Controller



CONTENTS

GENERAL INTRODUCTION.....	3
INITIAL INSPECTION.....	3
USING THE SENSOREX MODEL CX20.....	3
A. Mounting procedure.....	3
B. Front panel.....	4
C. LCD screen.....	5
D. Rear connectors.....	5
E. Measure mode.....	6
F. Setting mode.....	6
G. Conductivity/Resistivity calibration mode.....	10
H. Controlling the relays.....	10
ERROR DISPLAY AND TROUBLESHOOTING.....	11
SPECIFICATIONS.....	12
WARRANTY.....	13

GENERAL INTRODUCTION

Thank you for selecting the Sensorex CX20. The CX20 Conductivity/Resistivity Controller is a rugged microprocessor based instrument assembled in a watertight 1/8 DIN case, designed for use in laboratories and process control applications.

The system displays Conductivity / Resistivity or Temperature status in one large LCD screen.

The model CX20 microprocessor performs a self-diagnostic routine every time you turn on the unit, it will provide you with basic information on the stability of the instrument.

The model CX20 is equipped with 2 control relays. All control relays are programmable and hysteresis driven.

INITIAL INSPECTION

Carefully unpack the unit and accessories. Inspect for damages made in shipment. If any damage is found, notify your **Sensorex** representative immediately. All packing materials should be saved until satisfactory operation is confirmed.

USING THE SENSOREX CX20 Conductivity/Resistivity TRANSMITTER

A. Mounting Procedure

1. Make a cutout on any panel, with a thickness of 1/16 inch (1.5mm) to 3/8 inch (9.5mm). Refer to FIG 1

PANEL CUTOUT DIMENSIONS

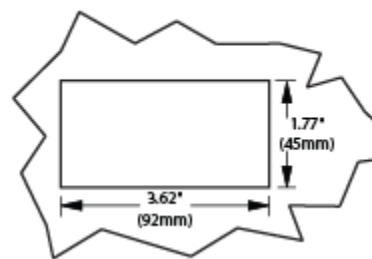

Figure 1

2. Remove the mounting bracket from the controller and insert the controller into the cutout. Refer to FIG 2.

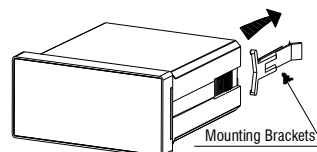

Figure 2

3. Replace the mounting bracket assembly onto the controller and secure the controller to the mounting panel. Refer to FIG 3.

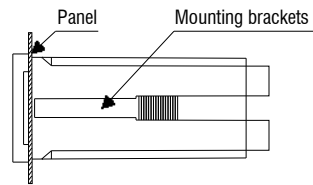
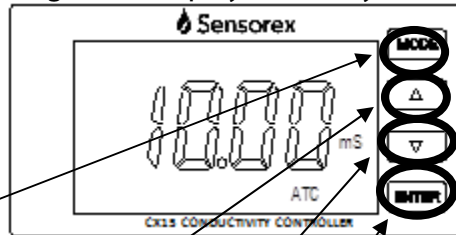

Figure 3

B. Front Panel

The front panel consists of a 4-digit LCD display and 4 keys.



1. **[MODE]** key:
 - 1a. In the **Measure mode**, this key will switch the display in sequence from Conductivity, Temperature and back to Conductivity again or from Resistivity, Temperature and back to Resistivity again.
 - 1b. In the **Calibration/Setting mode**, pressing this key for five seconds will move you back to the previous parameter in the case when recalibration / resetting is required.
2. **[UP]** key:
 - 2a. In the **Calibration mode**, pressing this key will increase the numeral increment. In the **Setting mode**, pressing this key will show the next possible option and increase the numeral increment.
 - 2b. In the **Measure mode**, pressing this key and **[ENTER]** key at the same time, the unit will enter the **Calibration mode**.
3. **[DOWN]** key:
 - 3a. In the **Calibration mode**, pressing this key will decrease the numeral increment. In the **Setting mode**, pressing this key will show the next possible option and decrease the numeral increment.
 - 3b. In the **Measure mode**, pressing this key and **[ENTER]** key at the same time, the unit will enter the **Setting mode**.
4. **[ENTER]** key:

In any mode where the user can change the settings, pressing this key will save the new settings. If no change has been made then pressing this key will just lead the user to the next setting.

C. LCD screen

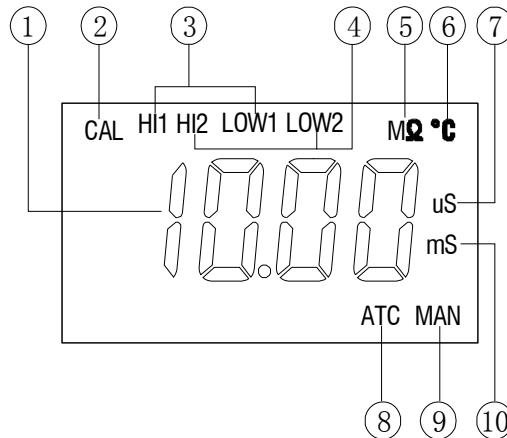

1. Major LCD display.
2. **CAL** – This icon will be displayed if the meter is in the **Calibration/Setting mode**.
3. **HI1 & LOW1** – These icons, when displayed, indicate relay action and relay number.
4. **HI2 & LOW2** –These icons, when displayed, indicate relay action and relay number.
5. MΩ– Unit indicator.
6. °C – Temperature and unit display.
7. **uS** – Unit indicator.
8. **ATC** –This icon will be displayed when a temperature probe is connected.
9. **MAN** –This icon will be displayed if no temperature probe is not connected.
10. **mS** – Unit indicator

D. Rear connectors

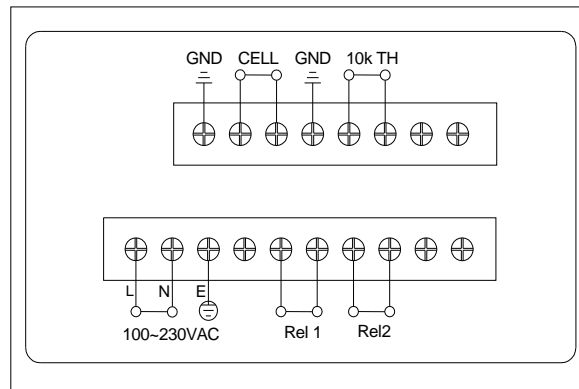

* Specify "L" = "Live Lead" 100 to 230 VAC Volts and "N" = "Neutral Lead"

1. Connect the AC line to the rear of the instrument. The model CX20 can be used with 100~240V AC at 50/60 HZ. Make sure the **EARTH** connector is connected to the earth lead of the AC power line.

2. Connect the proper load to the output relays. Make sure that the load does not exceed the relay rating, 5 Amp at 115VAC and 2.5 Amp at 230 VAC.

[Note] :

- (1) Make sure that the power is unplugged before wiring your probes etc.
- (2) Make sure you connect the AC power cord to the correct AC terminals. Incorrect connection may damage the unit permanently.

E. Measure mode

Turning on the unit will always display the **Measure mode**. This instrument is designed to provide 2 distinct measurements: Conductivity, Temperature or Resistivity, Temperature.

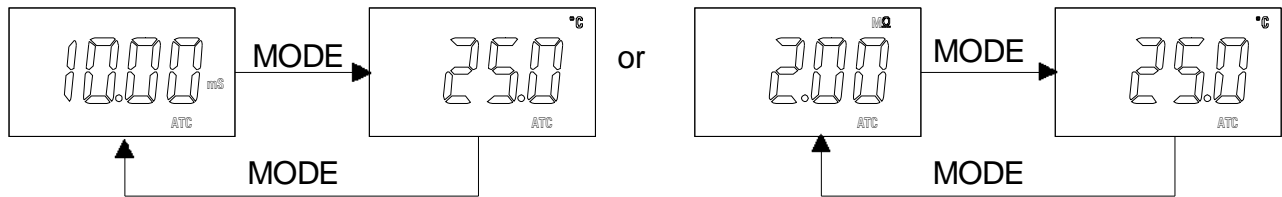

1. **Conductivity** – Current conductivity of the solution.
2. **Resistivity** –Current resistivity of the solution.
3. **Temperature** – Current temperature of the solution.

[Note] : Pressing **[MODE]** key in the **Measure mode** will cycle the display between the two modes above.

F. Setting mode

Pressing **[DOWN]** key and **[ENTER]** key at the same time, the meter will enter into the **Setting mode**.

1. **Temperature compensation select:**

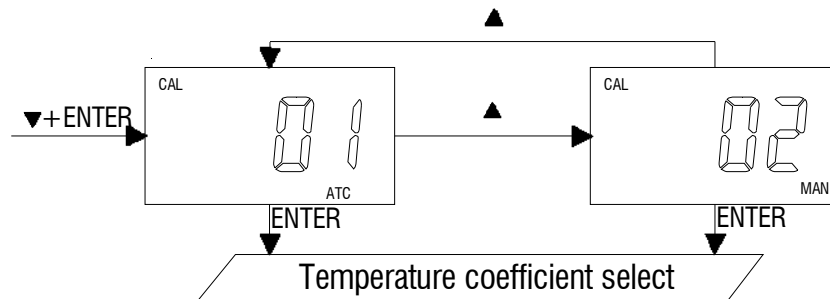

Pressing **[UP]** key or **[DOWN]** key in this screen will cycle the display between 01 (Thermistor: 10k ohm), 02 (Manual) modes above.

Select the preferred temperature compensation mode, press **[ENTER]** key to save, and enter the next setting screen.

2. Temperature Coefficient select:

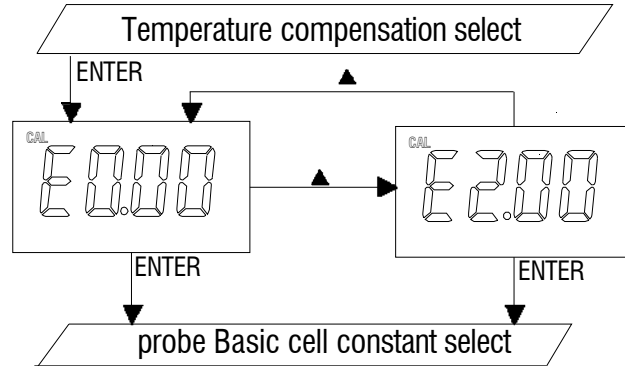

Pressing **[UP]** key or **[DOWN]** key in this screen will cycle the display between E2.00, E0.00 above.

Select the preferred coefficient, press **[ENTER]** key to save, and enter the next setting screen.

3. Probe Basic cell constant select:

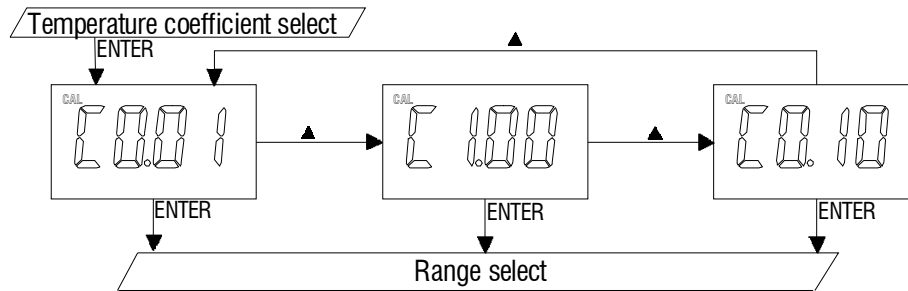

Pressing **[UP]** key or **[DOWN]** key in this screen will cycle the display from C1.00, C0.10 to C0.01 basic cell constant above.

Select the preferred basic cell constant, press **[ENTER]** key to save, and enter the next setting screen.

4. Range select:

Pressing **[UP]** key or **[DOWN]** key in this screen will cycle the display from CF01/0.000~1.999uS/cm, CF02/0.00~19.99uS/cm, CF03/0.000~1.999MΩ, CF04/0.00~19.99MΩ(**Basic cell K is C0.01**) or CF01/0.00~19.99uS/cm, CF02/0.0~199.9uS/cm(**Basic cell K is C0.10**) or CF01/0.0~199.9uS/cm, CF02/0~1999uS/cm, CF03/0.00~19.99mS/cm (**Basic cell K is C1.00**) above.

Select the preferred basic cell constant , press [ENTER] key to save, and enter the next setting screen.

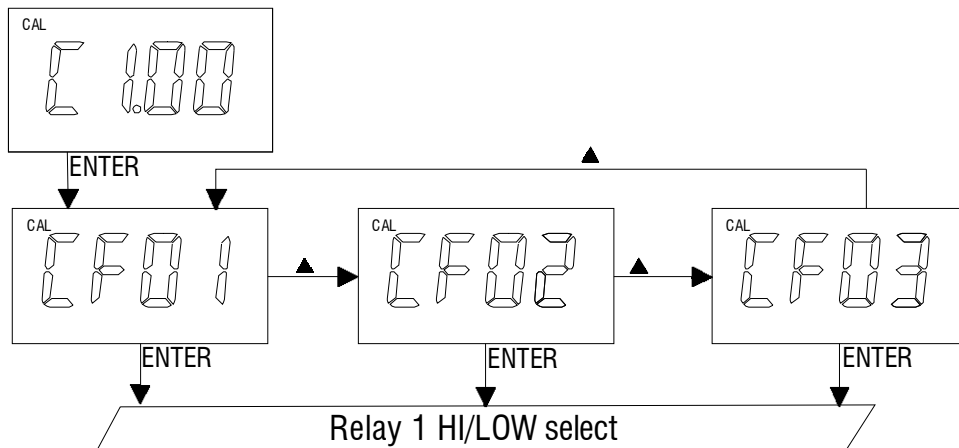
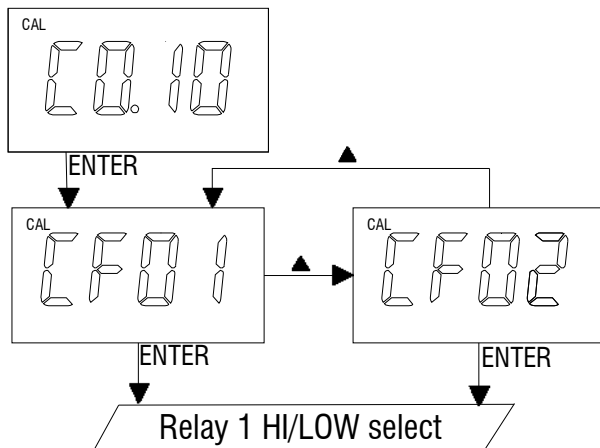
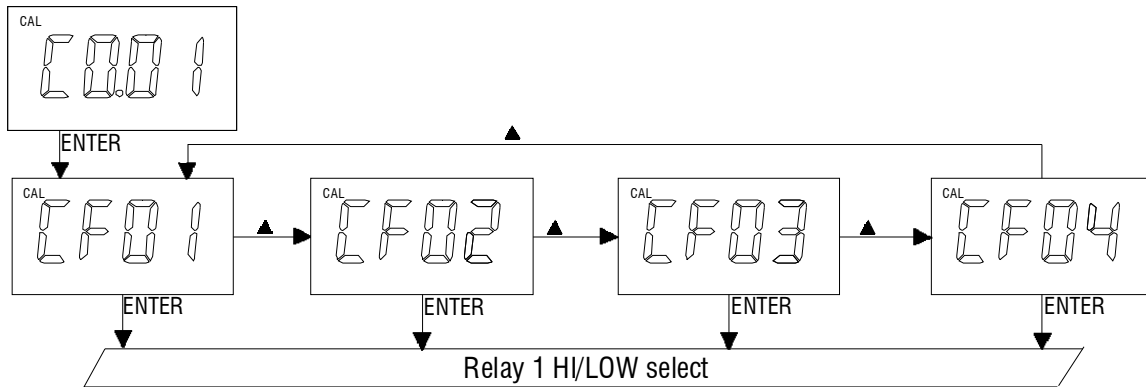

5. **Relay 1 High / Low select:**

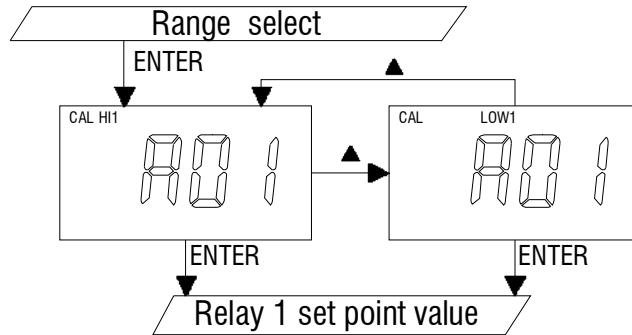

Pressing **[UP]** key or **[DOWN]** key in this screen will cycle the display from HI、 LOW modes above. Select the preferred mode, press **[ENTER]** key to save, and enter the next setting screen.

[Note] : See **“H. Controlling the relays ”** page.

6. **Relay 1 set point value :**

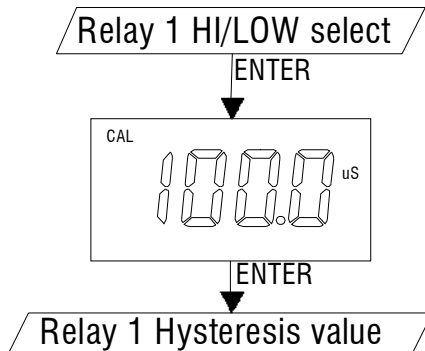

Pressing **[UP]** key or **[DOWN]** key in this screen to adjust the value, press **[ENTER]** key to save, and enter the next setting screen.

key or **[DOWN]** key in this screen value, press **[ENTER]** key to save, next setting screen.

7. **Relay 1 hysteresis value:**

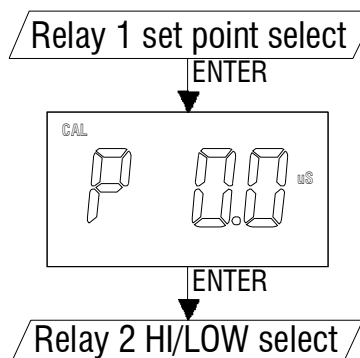

Pressing **[UP]** to adjust the and enter the

8. **Relay 2 High / Low select:**

Same as **“Relay 1 work way select”**

- 9. **Relay 2 set point value:**
Same as “Relay 1 set point value”
- 10. **Relay 2 hysteresis value:**
Same as “Relay 1 hysteresis value”

G. Conductivity/Resistivity Calibration mode

The model CX20 uses 1-point calibration for conductivity or resistivity. In the **Measure mode**, pressing [UP] key and [ENTER] key at the same time to allow the meter to go to the **Conductivity / Resistivity calibration mode**. At the **Conductivity / Resistivity calibration mode**, the “CAL” icon and a conductivity/resistivity reading will display. Rinse the conductivity probe in distilled water and immerse it into the standization solution. Allow temperature reading to stabilize, press [UP] key or [DOWN] key to change this reading to that of the standization solution value, then press [ENTER] key to save. Calibration is now completed.

H. Controlling the relays

- 1. **Isolation voltage:**
The maximum isolation voltage of the relay output contacts is 1500 VDC. The voltage differential between the relay output contacts and the load should not exceed 1500 VDC.
- 2. **Output load:**
The current through the relay output contacts should not exceed 5 Amp at 115 VAC and 2.5 Amp at 230 VAC in order not to cause permanent damage to the relay contacts. This rating is specified for resistive loads only.

3. **Relay action, relay set point and hysteresis value:**

Relay Action	Effective RELAY-ON Set Point	Effective RELAY-OFF Set Point
HI	S.P. + (1/2 H.V)	S.P. – (1/2 H.V)
LOW	S.P. – (1/2 H.V)	S.P. + (1/2 H.V.)

S.P. = Relay Set point H.V. = Hysteresis value (Dead Band)

If the relay action is set to **HIGH**, the relay will turn **ON** at (Set Point +1/2 Hysteresis), and will turn **OFF** at (Set Point -1/2 Hysteresis).

If the relay action is set to **LOW**, the relay will turn **ON** at (Set Point -1/2 Hysteresis), and will turn **OFF** at (Set Point +1/2 Hysteresis).

There are two Independent relays the user can bind to the **Conductivity** or **Resistivity mode**. The user can only bind the two relays to one reading mode at a time. The user can change this anytime by changing option at the **setting mode**.

ERROR DISPLAY AND TROUBLESHOOTING

Conductivity/R esistivity Display	Temperature Display	Display Mode	Possible cause(s) [Action(s)]
"OvEr"	- 10.0~120.0°C	Measure mode	Reading is over the specified range. [Change range to higher level]
"Undr"	- 10.0~120.0°C	Measure mode	Reading is under user specified range. [Change range to lower level] [Immerse the conductivity probe into standization solution.]
"OvEr"	"OvEr"	Measure mode	a. Temperature > 120.0°C. [Bring standization solution to lower temperature.] [Replace temperature probe.] b. No temperature sensor. [Adjust the manual temperature to -10~120°C.]
"OvEr"	"Undr"	Measure mode	a. Temperature < -10.0°C. [Bring standization solution to higher temperature.] [Replace temperature probe.] b. No temperature sensor. [Adjust the manual temperature to -10~120°C.]

SPECIFICATIONS

Conductivity/Resistivity:

Basic Cell K	Range	Resolution	Accuracy
0.01	0.000~1.999uS/cm 0.00~19.99MΩ	0.001uS/cm 0.01MΩ	±0.5%FS ± 1 digit
0.01	0.00~19.99uS/cm 0.000~1.999MΩ	0.01uS/cm 0.001MΩ	±0.5%FS ± 1 digit
0.10	0.00~19.99uS/cm	0.01uS/cm	±0.5%FS ± 1 digit
0.10	0.0~199.9uS/cm	0.1uS/cm	±0.5%FS ± 1 digit
1.00	0.0~199.9uS/cm	0.1uS/cm	±0.5%FS ± 1 digit
1.00	0~1999uS/cm	1uS/cm	±0.5%FS ± 1 digit
1.00	0.00~19.99mS/cm	0.01mS/cm	±0.5%FS ± 1 digit
Temperature	-10.0 to 120.0 °C	0.1 °C	±0.3 °C

Cell Constant	0.01, 0.1, 1.0; 2 wire.
Reference Temperature	25.0 °C, factory set.
Temperature Coefficient	2.00 or 0.00%, user selectable.
Temperature sensor (User selectable)	Thermistor: 10k ohm at 25 °C, Manual
Control type	Two ON/OFF control
Relay output (Resistive load only)	5A at 115VAC or 2.5A at 220VAC
Keys	Audio feedback in all keys
Power:	100VAC to 240VAC , 50/60Hz
Ambient Temperature range	0.0 to 50.0 °C
Case	IP65, 1/8DIN case, depth 90mm
Weight	290g

WARRANTY

Sensorex warrants this product to be free from significant deviations in material and workmanship for a period of 1 year from date of purchase. If repair or adjustment is necessary and has not been the result of abuse or misuse, within the year period, please return-freight-prepaid and the correction of the defect will be made free of charge. If you purchased the item from our **Sensorex** distributors and it is under warranty, please contact them to notify us of the situation. **Sensorex** Service Department alone will determine if the product problem is due to deviations or customer misuse.

Out-of-warranty products will be repaired on a charge basis.

RETURN OF ITEMS

Authorization must be obtained from one of our representatives before returning items for any reason. When applying for authorization, have the model and serial number handy, including data regarding the reason for return. For your protection, items must be carefully packed to prevent damage in shipment and insured against