

Operation Manual

TX20 1/8 DIN

Microcomputer Based pH/ORP Controller with relays



CONTENTS

GENERAL INTRODUCTION.....	3
INITIAL INSPECTION.....	3
USING THE SENSOREX TX20	3
A. Mounting procedure.....	3
B. Front panel.....	4
C. LCD screen.....	5
D. Rear connectors.....	6
E. Measure mode.....	7
F. Setting mode.....	7
G. pH calibration mode.....	10
H. RmV calibration mode.....	12
I. Controlling the relays.....	12
ERROR DISPLAY AND TROUBLESHOOTING.....	13
pH BUFFERS	14
SPECIFICATIONS.....	14
WARRANTY.....	15

GENERAL INTRODUCTION

Thank you for selecting the SENSOREX TX20 pH/ORP Controller, a rugged microprocessor based instrument assembled in a watertight 1/8 DIN case, designed for use in laboratories and process control applications.

The system displays pH or ORP or Temperature and relay status in one large LCD screen.

The TX20's microprocessor performs a self-diagnostic routine every time you turn on the unit providing you with basic information on the stability of the instrument.

The model TX20 is equipped with 2 control relays. All control relays are programmable and hysteresis driven.

INITIAL INSPECTION

Carefully unpack the unit and accessories. Inspect for damages made in shipment. If any damage is found, contact Sensorex or supplier immediately. All packing materials should be saved until satisfactory operation is confirmed.

USING THE SENSOREX TX20 pH/ORP TRANSMITTER

A. Mounting Procedure

1. Make a cutout on any panel, with a thickness of 1/16 inch (1.5mm) to 3/8 inch (9.5mm). Refer to FIG 1

PANEL CUTOUT DIMENSIONS

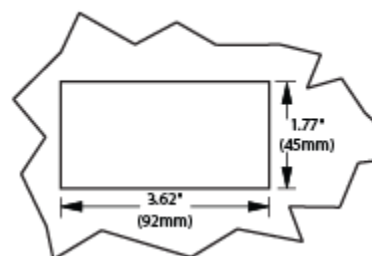

Figure 1

2. Remove the mounting bracket from the controller and insert the controller into the cutout. Refer to FIG 2.

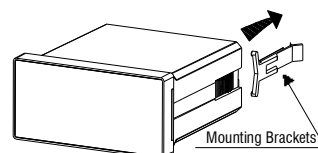

Figure 2

3. Replace the mounting bracket assembly onto the controller and secure the controller to the mounting panel. Refer to FIG 3.

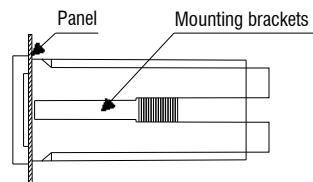

Figure 3

B. Front Panel

The front panel consists of a 4-digit LCD display and 4 keys.

1. [**MODE**] key:

1a. In the **Measure mode**, this key will switch the display in sequence from pH, Temperature, ORP absolute mV, ORP relative mV and back to pH again.

1b. In the **Calibration/Setting mode**, pressing this key for three seconds will move you back to the previous parameter in the case when recalibration / resetting is required.

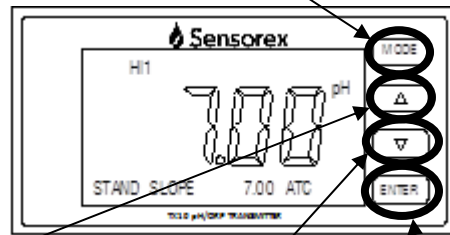

2. [**UP**] key:

2a. In the **Calibration mode**, pressing this key will show the next possible option. In the **Setting mode**, pressing this key will show the next possible option and increases the numeral increment.

2b. In the **Measure mode**, pressing this key and [**ENTER**] key at the same time, the unit will enter the **Calibration mode**.

3. [**DOWN**] key:

3a. In the **Calibration mode**, pressing this key will show the next possible option. In the **Setting mode**, pressing this key will show the next possible option and decreases the numeral increment.

3b. In the **Measure mode**, pressing this key and [**ENTER**] key at the same time, the unit will enter the **Setting mode**.

4. [**ENTER**] key:

In any mode where the user can change the settings, pressing this key will save the new settings. If no change has been made then pressing this key will just move the user to the next setting.

C. **LCD screen**

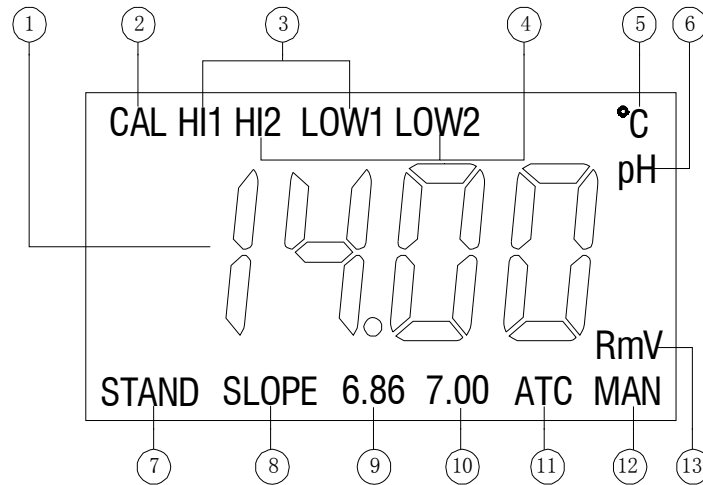

1. Major LCD display.
2. **CAL** – This icon will be displayed if the meter is in the **Calibration/Setting mode**.
3. **HI1 & LOW1** – These icons, when displayed, indicate relay action and relay number.
4. **HI2 & LOW2** – These icons, when displayed, indicate relay action and relay number.
5. **°C** – Temperature and unit display.
6. **pH** – Unit indicator.
7. **STAND** – This icon will blink before Buffer 1 calibration. The icon will stay on while Buffer 1 is being calibrated.
8. **SLOPE** – This icon will blink before Buffer 2 calibration. The icon will stay on while Buffer 2 is being calibrated.
9. **6.86** – The 6.86 buffer group: 6.86, 4.00, 9.18.
10. **7.00** – The 7.00 buffer group: 7.00, 4.01, 10.01.
11. **ATC** – This icon will be displayed when a temperature probe is connected.
12. **MAN** – This icon will be displayed when a temperature probe is not connected.
13. **RmV** – Unit indicator.

D. Rear connectors

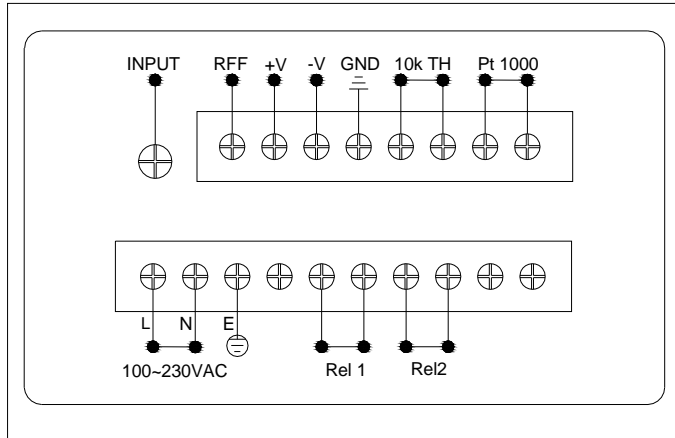

1. Connect the AC line to the rear of the instrument. The model TX20 can be used with 100~240V AC at 50/60 HZ. Make sure the **EARTH** connector is connected to the earth lead of the AC power line.
2. Connect the proper load to the output relays. Make sure that the load does not exceed the relay rating, 5 Amp at 115VAC and 2.5 Amp at 230 VAC.
3. V+ (5VDC) and V- (5VDC) output to provide excitation voltage for pH/ORP pre-amplifier only.

[Note] :

- (1) Make sure that the power is unplugged before wiring your probes, relay etc.
- (2) Make sure you connect the AC power cord to the correct AC terminals. Connecting incorrectly may damage the unit permanently.

Measure mode

Turning on the unit will always display the **Measure mode**. This instrument is designed to provide 4 distinct measurements:

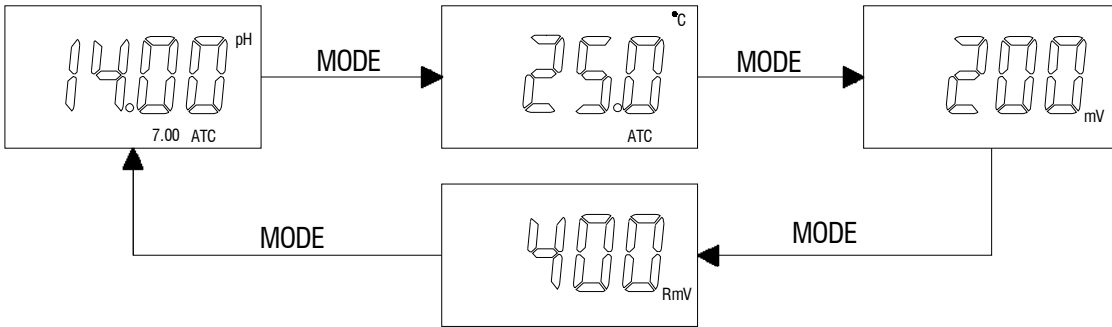

1. **pH** – The degree of acidity or alkalinity of the solution.
2. **Temperature** – Current temperature of the solution.
3. **ORP mV** – A measurement of absolute ORP mV.
4. **ORP RmV**– A measurement of relative ORP mV. The offset value at the RmV calibration will be added to the ORP absolute value to display the ORP relative value.

[Note] :

ORP relative value range: ORP absolute value - 1000mV to ORP absolute value + 1000mV

Pressing [**MODE**] key in the **Measure mode** will cycle the display from the four modes above.

E. Settings mode

Pressing [**DOWN**] key and [**ENTER**] key at the same time, the meter will enter into the **Setting mode**.

1. **Temperature compensation select:**

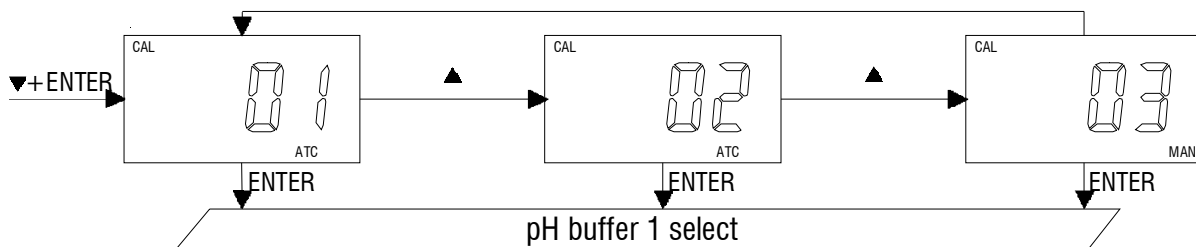

Pressing [**UP**] key or [**DOWN**] key in this screen will cycle the display from 01 (Thermistor: 10k ohm), 02 (Resistor: PT1000), 03 (Manual) modes above.

Select the preferred temperature compensation mode, press [**ENTER**] key to save, and enter the next setting screen.

2. **pH buffer 1 select:**

Pressing **[UP]** key or **[DOWN]** key in this screen will cycle the display from 7.00, 6.86 buffer above.

Select the preferred buffer, press **[ENTER]** key to save, and enter the next setting screen.

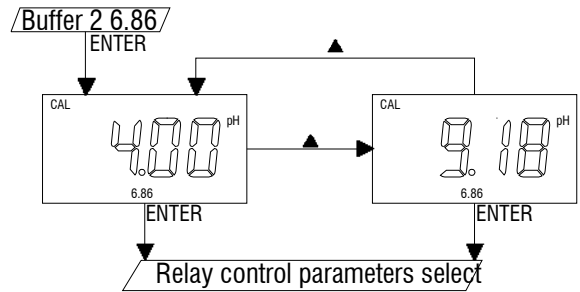
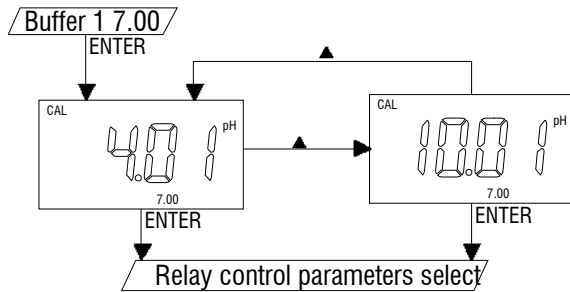
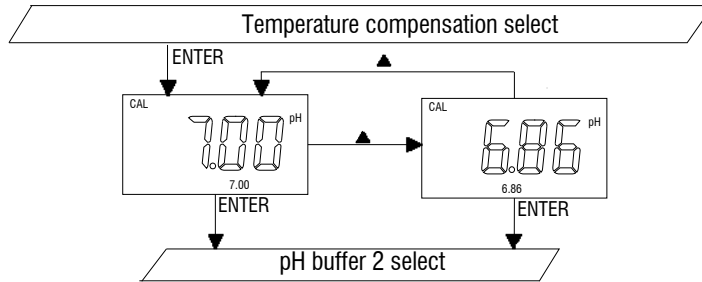

Pressing **[UP]** key or **[DOWN]** key in this screen will cycle the display from 4.01, 10.01 (or 4.00, 9.18) buffer above.

Select the preferred buffer, press **[ENTER]** key to save, and enter the next setting screen.

[Note] : The pH buffer 2 is either 4.01 or 10.01 if select 7.00 buffer at pH buffer 1 select screen. The pH buffer 2 is either 4.00 or 9.18 if select 6.86 buffer at pH buffer 1 select screen.

3. **Relay control parameters select:**

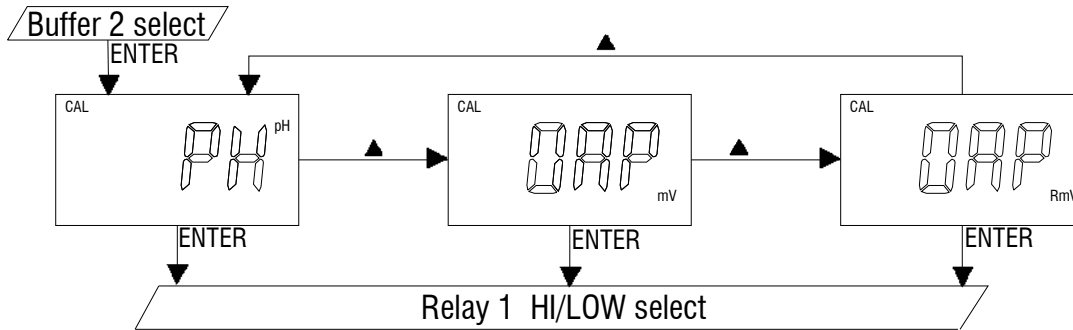

Pressing **[UP]** key or **[DOWN]** key in this screen will cycle the display from pH, ORP mV ORP RmV modes above.

Select the preferred mode, press **[ENTER]** key to save, and enter the next setting screen.

[Note] : The relay will work with the choice of parameters.

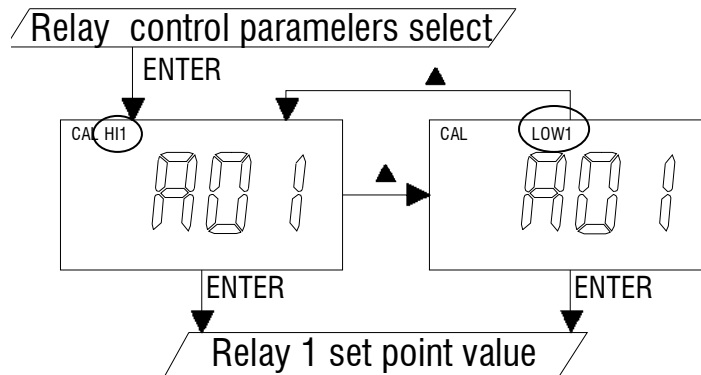

4. Pressing **[UP]** key or **[DOWN]** key in this screen will cycle the display from HI、 LOW modes above. Select the preferred mode, press **[ENTER]** key to save, and enter the next setting screen.

5. **[Note]** : See **"I. Controlling the relays"** page.

6. **Relay 1 set point value:**

Pressing **[UP]** key or **[DOWN]** key in this screen to adjust the value, press **[ENTER]** key to save, and enter the next setting screen.

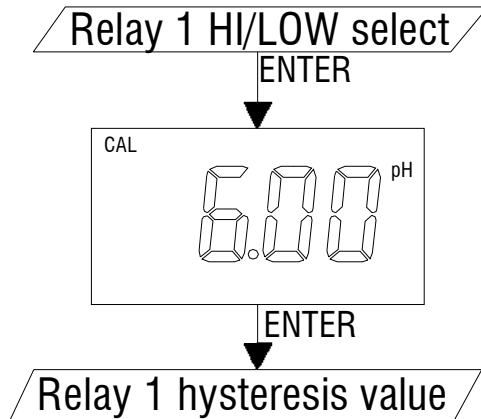

7. Relay 1 hysteresis value:

Pressing [UP] key or [DOWN] key in this screen to adjust the value, press [ENTER] key to save, and enter the next setting screen.

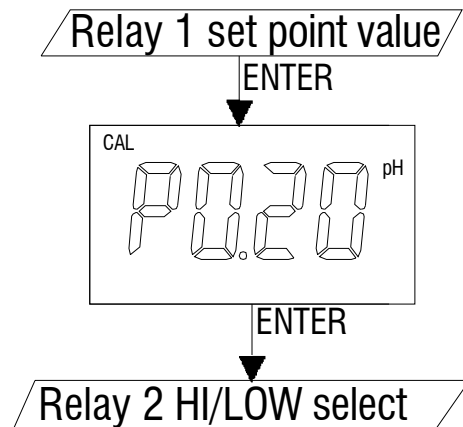

8. **Relay 2 High / Low select:** Same as "Relay 1 work way select"

9. **Relay 2 set point value:** Same as "Relay 1 set point value"

10. **Relay 2 hysteresis value:** Same as "Relay 1 hysteresis value"

G. pH Calibration mode

The TX20 uses 2-point calibration for pH. The first point must be 6.86/7.00, and the second point can either be 4.00/4.01 or 9.18/ 10.01.

In the pH Measure mode, pressing [UP] key and [ENTER] key at the same time to allow the meter to go to the pH Calibration mode.

1. Buffer 1 (STAND) calibration:

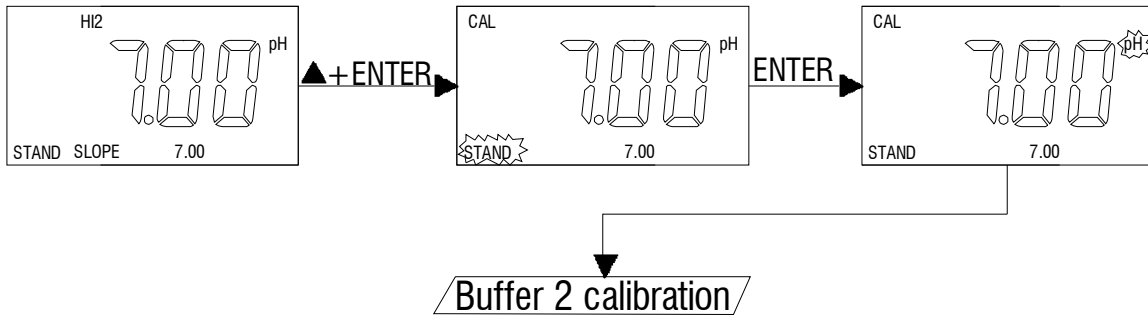

Enter into the pH calibration mode, the “**STAND**” icon will flash, the unit is ready to be standardized at the first buffer. Rinse the pH and ATC/Temp probes in distilled water and immerse them in the first buffer solution (either 7.00 or 6.86). Allow temperature reading to stabilize, then press “**ENTER**” key to calibrate. The “**pH**” icon will flash until the unit detects a stable reading. Once the unit calibrates the first point, the “**SLOPE**” icon will flash. The unit is ready to be sloped at the second buffer.

2. Buffer 2 (SLOPE) calibration:

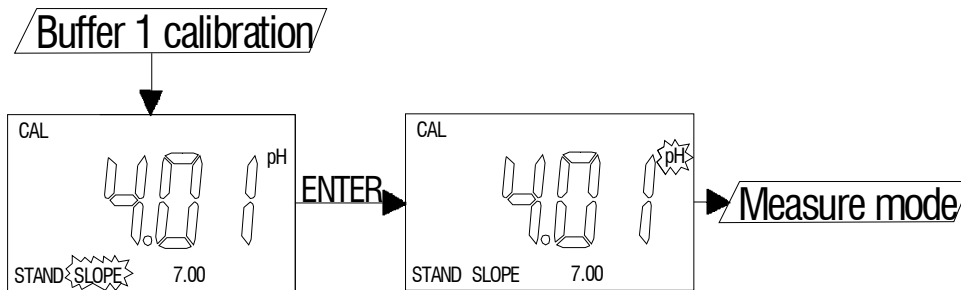

Rinse the pH and ATC/Temp probe in distilled water and immerse them in the second buffer solution (either 4.00/4.01 or 9.18/10.01). Allow temperature reading to stabilize, then press “**ENTER**” key to calibrate. The “**pH**” icon will flash until the unit detects a stable reading. Once the unit calibrates the second point and the unit will automatically exit the **calibration mode** and goes to the pH **Measure mode**. Dual point calibration is complete.

[Note] : In the **Setting mode** (1. Temperature compensation select), select 03 (Manual temperature compensation mode) if no temperature probe is being used. Press the **[UP]** key or **[DOWN]** key in the **Manual temperature compensation mode** to adjust the value to that of the test solution temperature. Then calibrate buffer 1 and buffer 2.

F. RmV Calibration mode

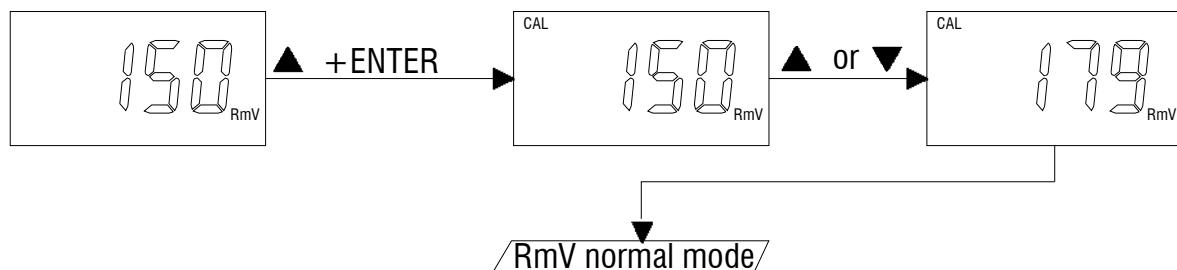

The model TX20 uses 1-point calibration for RmV. In the **RmV Measure mode**, pressing [**UP**] key and [**ENTER**] key at the same time, the meter will enter into **RmV calibration mode**. Rinse the ORP probe in distilled water and immerse it in the ORP standard solution, then press [**UP**] or [**DOWN**] key to adjust the ORP value to that the ORP standard. Press [**ENTER**] key to save. The unit beeps to indicate a successful calibration. Calibration is now complete and the unit will automatically switch to the ORP relative mV **Measure mode**.

[Note] : When the ORP absolute mV reading is off, recalibrate RmV value.

G. Controlling the relays

1. **Isolation voltage:**

The maximum isolation voltage of the relay output contacts is 1500 VDC. The voltage differential between the relay output contacts and the load should not exceed 1500 VDC.

2. **Output load:**

The current through the relay output contacts should not exceed 5 Amp at 115 VAC and 2.5 Amp at 230 VAC in order not to cause permanent damage to the relay contacts. This rating is specified for resistive loads only.

3. **Relay action, relay set point and hysteresis value:**

Relay Action	Effective RELAY-ON Set Point	Effective RELAY-OFF Set Point
HI	S.P. + (1/2 H.V)	S.P. - (1/2 H.V)
LOW	S.P. - (1/2 H.V)	S.P. + (1/2 H.V.)

S.P. = Relay Set point H.V. = Hysteresis value (Dead Band)

If the relay action is set to **HIGH**, the relay will turn **ON** at (Set Point +1/2 Hysteresis), and will turn **OFF** at (Set Point -1/2 Hysteresis).

If the relay action is set to **LOW**, the relay will turn **ON** at (Set Point -1/2 Hysteresis), and will turn **OFF** at (Set Point +1/2 Hysteresis).

There are two Independent relays the user can bind to the **pH**, **ABSOLUTE mV** or **RELATIVE mV mode**. The user can only bind the two relays to one reading mode at a time. The user can change this anytime by changing option at the **setting mode**.

[Note] :

1. The ideal set point range for pH is 0.00 to 16.00 pH.
2. The ideal set point range for absolute mV is -2000 to 2000 mV.
3. The ideal set point range of for relative mV is -3000 to 3000 mV.

ERROR DISPLAY AND TROUBLESHOOTING

pH/ORP Display	Temperature Display	Display Mode	Possible cause(s) [Action(s)]
"OvEr"	-10.0~120.0°C	pH measure mode	pH > 16.00pH [Recalibrate]
"Undr"	-10.0~120.0°C	pH measure mode	pH < -2.00pH [Recalibrate]
"OvEr"	"OvEr"	pH measure mode	a. Temperature > 120.0°C. [Bring buffer solution to lower temperature.] [Replace temperature probe.] b. No temperature sensor. [Adjust the manual temperature to -10~120°C.]
"OvEr"	"Undr"	pH measure mode	a. Temperature < -10.0°C. [Bring buffer solution to higher temperature.] [Replace temperature probe.] b. No temperature sensor. [Adjust the manual temperature to -10~120°C.]
"OvEr"	Temperature reading	Absolute ORP mV or relative ORP	Absolute ORP mV > +1999 mV [Bring solution to a lower ORP reading]
"Undr"	Temperature reading	Absolute ORP mV or relative ORP	Absolute ORP mV < -1999 mV [Bring solution to a higher ORP reading]
ORP reading	"OvEr"	Absolute ORP mV or relative ORP	a. Temperature > 120.0°C. [Bring buffer solution to lower temperature.] [Replace temperature probe.] b. No temperature sensor. [Adjust the manual temperature to -10~120°C.]
ORP reading	"Uder"	Absolute ORP mV or relative ORP	a. Temperature < -10.0°C. [Bring buffer solution to higher temperature.] [Replace temperature probe.] b. No temperature sensor. [Adjust the manual temperature to -10~120°C.]
"OvEr"	0~60°C	a. pH calibration mode-Buffer 1 (STAND)-7.00 b. pH calibration mode-Buffer 1 (STAND)-6.86 c. pH calibration mode-Buffer 2 (SLOPE)	a. Offset < -100 or > 100 mV b. Offset < -91.7 or > 108.3 mV c. Slope > ideal mV by 30% [Use a new buffer solution.] [Replace electrode.]

pH BUFFERS

The temperature characteristics of pH calibration buffers pH4.00, pH4.01, pH6.86, pH7.00, pH9.18 & pH10.01 are stored inside the instrument. The buffers used to calibrate the instrument must exhibit the same temperature characteristics as the stored values.

°C	4.00	6.86	9.18	4.01	7.00	10.01
0	4.01	6.98	9.46	4.01	7.11	10.32
5	4.00	6.95	9.39	4.01	7.08	10.25
10	4.00	6.92	9.33	4.00	7.06	10.18
15	4.00	6.90	9.28	4.00	7.03	10.12
20	4.00	6.88	9.23	4.00	7.01	10.06
25	4.00	6.86	9.18	4.01	7.00	10.01
30	4.01	6.85	9.14	4.01	6.98	9.97
35	4.02	6.84	9.10	4.02	6.98	9.93
40	4.03	6.84	9.07	4.03	6.97	9.89
45	4.04	6.83	9.04	4.04	6.97	9.86
50	4.06	6.83	9.02	4.06	6.97	9.83
55	4.07	6.83	8.99	4.08	6.97	9.80
60	4.09	6.84	8.97	4.10	6.98	9.78

【Note】 : The actual reading of the instrument can differ from the values shown by ± 0.01 pH.

SPECIFICATIONS

Mode	Range	Resolution	Accuracy
pH	-2.00 to 16.00 pH	0.01 pH	$\pm 0.1\% \pm 1$ digit
ORP Absolute mV	-1999 to 1999 mV	1 mV	$\pm 0.1\% \pm 1$ digit
ORP Relative mV	-2999 to 2999 mV	1 mV	$\pm 0.1\% \pm 1$ digit
Temperature	-10.0 to 120.0 °C	0.1 °C	± 0.3 °C

pH:

Recognized pH buffers	US (4.01, 7.00, 10.01) or NIST (4.00, 6.86, 9.18)
pH Temperature compensation	Manual/Auto -10.0°C to 120.0 °C
pH Buffer Temperature range	0.0°C to 60.0 °C
pH Electrode Offset recognition	+/-100 mV at pH 7.00 +108.3 mV/-91.7 mV at pH 6.86
pH Electrode Slope recognition	+/- 30% at pH 4.00, 4.01, 9.18, 10.01
Input impedance	$>10^{12} \Omega$
Calibration end point sensing	Yes

Temperature:

Temperature sensor Thermistor: 10k ohm at 25 °C, (User selectable)
Resistor (PT1000) or Manual

Controller:

Control type Two ON/OFF control
Relay output(Resistive load only) 5A at 115VAC or 2.5A at 220VAC

General:

Keys Audio feedback in all keys
Power: 100VAC to 240VAC , 50/60Hz
Ambient Temperature range 0.0 to 50.0 °C
Case IP65, 1/8DIN case, depth 90mm
Weight 290 g

WARRANTY

Sensorex warrants this product to be free from significant deviations in material and workmanship for a period of 1 year from date of purchase. If repair or adjustment is necessary and has not been the result of abuse or misuse, within the year period, please return-freight-prepaid and the correction of the defect will be made free of charge. If you purchased the item from our **Sensorex** distributors and it is under warranty, please contact them to notify us of the situation. **Sensorex** Service Department alone will determine if the product problem is due to deviations or customer misuse. Out-of-warranty products will be repaired on a charge basis.

RETURN OF ITEMS

Authorization must be obtained from one of our representatives before returning items for any reason. When applying for authorization, have the model and serial number handy, including data regarding the reason for return. For your protection, items must be carefully packed to prevent damage in shipment and insured against possible damage or loss. **Sensorex** will not be responsible for damage resulting from careless or insufficient packing. A fee will be charged on all authorized returns.

【Note】 : **Sensorex** reserves the right to make improvements in design, construction and appearance of our products without notice.